

SIRUBA®

銀爺牌工業用縫紉機

INDUSTRIAL SEWING MACHINE

700K

零件圖 PARTS LIST



CE







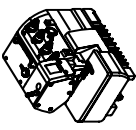

高林股份有限公司
KAULIN MFG. CO., LTD.

機型 MODEL	針板 NEEDLE PLATE	送具 FEED DOG	送具 FEED DOG	送具 FEED DOG	押具 PRESSER FOOT	勾針 LOOPER	針留 NEEDLE CLAMP	束子 COLLER	衝程 CRANK	衝程 CRANK	大心 Crankshaft	勾針連桿座 Upper Looper Holder	過線器 Bracket	下刀架 Lower Knife Holder	針號 NEEDLE
737K-504F1-04	E206	D201	D207	H201	P201-4A	LP225	KG231K-E	KJ204	KF203-E	KJ206-E	KD201	KJ236	KJ219	KR209	DC27#9
737K-504F1-15	E233	D233	D213	H233	P471J-A	LP225	KG231K-E	KJ204	KF203-E	KJ206-E	KD201	KJ236	KJ219	KR209	DC27#9
737K-504MI-15	E207	D201	D209	H201	P211-A	LP225	KG231K-E	KJ204	KF203-E	KJ206-E	KD201	KJ236	KJ219	KR209	DC27#9
737K-504MI-15VT	E207	D201	D209	H201	P211-A	LP225	KG231K-E	KJ204	KF203-E	KJ206-E	KD201	KJ236	KJ219	KR209	DC27#9
737K-504M2-04	E222	D210	D207	H204	P201-4A	LP225	KG231K-E	KJ204	KF203-E	KJ206-E	KD201	KJ236	KJ219	KR209	DC27#11
737K-504M2-04CT	E222	D210	D207	H204	P201-4A	LP225	KG231K-E	KJ204	KF203-E	KJ206-E	KD201	KJ236	KJ219	KR209	DC27#11
737K-504M2-04EC	E222	D210	D207	H204	P201-4A	LP225	KG231K-E	KJ204	KF203-E	KJ206-E	KD201	KJ236	KJ219	KR209	DC27#11
737K-504M2-04LFC-3	E222	D210	D207	H204	P216-3	LP225	KG231K-E	KJ204	KF203-E	KJ206-E	KD201	KJ236	KJ219	KR209	DC27#11
737K-504M2-04LFC-3/EC	E222	D210	D207	H204	P216-3	LP225	KG231K-E	KJ204	KF203-E	KJ206-E	KD201	KJ236	KJ219	KR209	DC27#11
737K-504M2-04TR	E222	D210	D207	H204	P216-3	LP225	KG231K-E	KJ204	KF203-E	KJ206-E	KD201	KJ236	KJ219	KR209	DC27#11
737K-504M2-04TR/EC	E222	D210	D207	H204	P216-3	LP225	KG231K-E	KJ204	KF203-E	KJ206-E	KD201	KJ236	KJ219	KR209	DC27#11
737K-504M2-04VT	E222	D210	D207	H204	P201-4A	LP225	KG231K-E	KJ204	KF203-E	KJ206-E	KD201	KJ236	KJ219	KR209	DC27#11
737K-WR/LFC-3	E246					LP225	KG231K-E	KJ204	KF203-E	KJ206-E	KD201	KJ236	KJ219	KR209	DC27#11
737K-504M3-04	E220	D210	D209	H204	P201-4A	LP225	KG231K-E	KJ204	KF203-E	KJ206-E	KD201	KJ236	KJ219	KR209	DC27#11
737K-504M3-05	E221	D210	D209	H204	P201-4A	LP225	KG231K-E	KJ204	KF203-E	KJ206-E	KD201	KJ236	KJ219	KR209	DC27#11
737K-504M3-05CT	E221	D210	D209	H204	P201-4A	LP225	KG231K-E	KJ204	KF203-E	KJ206-E	KD201	KJ236	KJ219	KR209	DC27#11
737K-504M3-05PZ	E221	D210	D209	H204	P257-A	LP225	KG231K-E	KJ204	KF203-E	KJ206-E	KD201	KJ236	KJ219	KR209	DC27#18
737K-504M3-05VT	E221	D210	D209	H204	P201-4A	LP225	KG231K-E	KJ204	KF203-E	KJ206-E	KD201	KJ236	KJ219	KR209	DC27#11
737K-504M5-04BK	E232	D203	D207	H203	P202-2A	LP225	KG231K-E	KJ204	KF203-E	KJ206-E	KD201	KJ236	KJ219	KR209	DC27#11
737K-504M5-04BK/VT	E232	D203	D207	H203	P202-2A	LP225	KG231K-E	KJ204	KF203-E	KJ206-E	KD201	KJ236	KJ219	KR209	DC27#11
737K-505F1-04	E206	D201	D207	H201	P203-A	LP225	KG231K-E	KJ204	KF203-E	KJ206-E	KD201	KJ236	KJ219	KR209	DC27#9
737K-505F1-04VT	E206	D201	D207	H201	P203-A	LP225	KG231K-E	KJ204	KF203-E	KJ206-E	KD201	KJ236	KJ219	KR209	DC27#9
747K-512M1-25	E208	D210	D207	H204	P201-5A	LP228	KG242K-E	KJ204	KF215-E	KJ203-E	KD201	KJ208	KJ219	KR209	DC27#11*2
747K-512M1-25CT	E208	D210	D207	H204	P201-5A	LP228	KG242K-E	KJ204	KF215-E	KJ203-E	KD201	KJ208	KJ219	KR209	DC27#11*2
747K-512M1-34	E236	D210	D207	H204	P214-A	LP228	KG254K-E	KJ204	KF215-E	KJ203-E	KD201	KJ208	KJ219	KR209	DC27#14*2
747K-514F1-24	E212	D210	D207	H204	P201-3A	LP229	KG242K-E	KJ234+KL15	KF203-E	KJ203-E	KD201	KJ208	KJ219	KR209	DC27#11*2
747K-514H4-24GA	E229	D202	D207	H202	P204-A	LP226	KG242K-E	KJ234+KL15	KF203-E	KJ203-E	KD201	KJ208	KJ219	KR209	DC27#11*2
747K-514H4-24GA/CT	E229	D202	D207	H202	P204-A	LP226	KG242K-E	KJ234+KL15	KF203-E	KJ203-E	KD201	KJ208	KJ219	KR209	DC27#11*2
747K-514H4-24GA/EC	E229	D202	D207	H202	P204-A	LP226	KG242K-E	KJ234+KL15	KF203-E	KJ203-E	KD201	KJ208	KJ219	KR209	DC27#11*2
747K-514H4-24GA/P	E229	D202	D207	H202	P204P-A	LP226	KG242K-E	KJ234+KL15	KF203-E	KJ203-E	KD201	KJ208	KJ219	KR209	DC27#11*2
747K-514M2-24	E229	D210	D207	H204	P201-A	LP226	KG242K-E	KJ234+KL15	KF203-E	KJ203-E	KD201	KJ208	KJ219	KR209	DC27#11*2
747K-514M2-24CT	E229	D210	D207	H204	P201-A	LP226	KG242K-E	KJ234+KL15	KF203-E	KJ203-E	KD201	KJ208	KJ219	KR209	DC27#11*2
747K-514M2-24EC	E229	D210	D207	H204	P201-A	LP226	KG242K-E	KJ234+KL15	KF203-E	KJ203-E	KD201	KJ208	KJ219	KR209	DC27#11*2

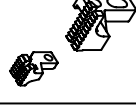
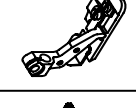
規格件表 CONVERSION CHART

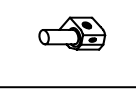
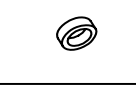
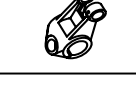
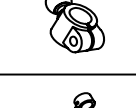
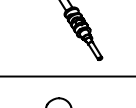
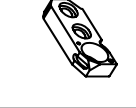
規格件表 CONVERSION CHART

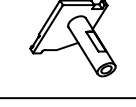
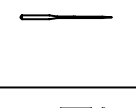
													
機 型 MODEL	針板 NEEDLE PLATE	送具 FEED DOG	押具 PRESSER FOOT	勾針 LOOPER	針留 NEEDLE CLAMP	束子 COLLER	衝程 CRANK	衝程 CRANK	大 心 Crankshaft	勾針連焊座 Upper Looper Holder	過線器 Bracket	下刀架 Lower Knife Holder	針 號 NEEDLE
747K-514M2-24LFC-3	E229	D210	P216-4	LP226	KG242K-E	KJ234+KJL15	KF203-E	KJ203-E	KD201	KJ208	KJ219	KR209	DC27#11*2
747K-514M2-24LFC-3/EC			P216-4										
747K-514M2-24TG			P254J-4A			KJ234+KJL15	KF203-E	KJ203-E	KD201	KJ208			
747K-514M2-24TG/EC			-J-4A		KG242K-E	KJ234+KJL15	KF203-E	KJ203-E	KD201	KJ208	KJ219	KR209	DC27#11*2
747K-514M2-24VT	E229	D210	P201-A	LP226	KG242K-E	KJ234+KJL15	KF203-E	KJ203-E	KD201	KJ208	KJ219	KR209	DC27#11*2
747K-514M2-25	E208	D210	P201-A	LP226	KG242K-E	KJ234+KJL15	KF203-E	KJ203-E	KD201	KJ208	KJ219	KR209	DC27#11*2
747K-514M2-25CT	E208	D210	P201-A	LP226	KG242K-E	KJ234+KJL15	KF203-E	KJ203-E	KD201	KJ208	KJ219	KR209	DC27#11*2
747K-514M2-25CT	E208	D210	P254J-4A	LP226	KG242K-E	KJ234+KJL15	KF203-E	KJ203-E	KD201	KJ208	KJ219	KR209	DC27#11*2
747K-514M2-25TG	E230	D210	P201-8A	LP227A	KG242K-E	KJ204+KJ234*2	KF203-E	KJ203-E	KD201A	KJ228	KJ238	KR209	DC27#11*2
747K-514M2-28	E209	D210	P201-2A	LP226	KG242K-E	KJ234+KJL15	KF203-E	KJ203-E	KD201	KJ208	KJ219	KR209	DC27#11*2
747K-514M4-23	E209	D210	P201-2A	LP226	KG242K-E	KJ234+KJL15	KF203-E	KJ203-E	KD201	KJ208	KJ219	KR209	DC27#11*2
747K-514M4-23/CT	E209	D210	P201-2A	LP226	KG242K-E	KJ234+KJL15	KF203-E	KJ203-E	KD201	KJ208	KJ219	KR209	DC27#11*2
747K-514M5-23BK	E210	D203	P202-A	LP226	KG242K-E	KJ234+KJL15	KF203-E	KJ203-E	KD201	KJ208	KJ219	KR209	DC27#11*2
747K-514M5-23BK/VT	E210	D203	P202-A	LP226	KG242K-E	KJ234+KJL15	KF203-E	KJ203-E	KD201	KJ208	KJ219	KR209	DC27#11*2
747K-514M7-24BK	E226	D212	P201-A	LP230	KG242K-E	KJ204+KJ234*2	KF203-E	KJ203-E	KD201A	KJ228	KJ238	KR209	DC27#16*2
747K-514M7-24BK	E247	D203	P202-A	LP230	KG242K-E	KJ204+KJ234*2	KF203-E	KJ203-E	KD201A	KJ228	KJ238	KR209	DC27#16*2
747K-514M7-24CT	E226	D212	P201-A	LP230	KG242K-E	KJ204+KJ234*2	KF203-E	KJ203-E	KD201A	KJ228	KJ238	KR209	DC27#16*2
747K-514M7-24TG	E226	D212	P254J-4A	LP230	KG242K-E	KJ204+KJ234*2	KF203-E	KJ203-E	KD201A	KJ228	KJ238	KR209	DC27#16*2
747K-514M7-25	E225	D212	P201-5A	LP230	KG242K-E	KJ204+KJ234*2	KF203-E	KJ203-E	KD201A	KJ228	KJ238	KR209	DC27#16*2
747K-514M7-25BK	E248	D203	P202-A	LP230	KG242K-E	KJ204+KJ234*2	KF203-E	KJ203-E	KD201A	KJ228	KJ238	KR209	DC27#16*2
747K-514M7-25CT	E225	D212	P201-5A	LP230	KG242K-E	KJ204+KJ234*2	KF203-E	KJ203-E	KD201A	KJ228	KJ238	KR209	DC27#16*2
747K-514M7-25TG	E225	D212	P254J-4A	LP230	KG242K-E	KJ204+KJ234*2	KF203-E	KJ203-E	KD201A	KJ228	KJ238	KR209	DC27#16*2
757K-401M1/TW	E237	D219	P506-A		KG253K-E	KJ204	KF203-E	KJ206-E	KD201	TW201			DC27#14*1
757K-516H4-35GA	E213	D204	P508J-A	LP226	KG253K-E	KJ204	KF203-E	KJ206-E	KD201	KJ236	KJ219	KR219	DC27#14*2
757K-516H4-35GA/EC	E213	D204	P508J-A	LP226	KG253K-E	KJ204	KF203-E	KJ206-E	KD201	KJ236	KJ219	KR219	DC27#14*2
757K-516H4-35GA/P	E213	D204	P508JP-A	LP226	KG253K-E	KJ204	KF203-E	KJ206-E	KD201	KJ236	KJ219	KR219	DC27#14*2
757K-516H4-35GA/P/EC	E213	D204	P508JP-A	LP226	KG253K-E	KJ204	KF203-E	KJ206-E	KD201	KJ236	KJ219	KR219	DC27#14*2
757K-516H4-55GA	E214	D205	P509J-A	LP226	KG255K-E	KJ204	KF203-E	KJ206-E	KD201	KJ236	KJ219	KR219	DC27#14*2
757K-516H4-55GA/EC	E214	D205	P509J-A	LP226	KG255K-E	KJ204	KF203-E	KJ206-E	KD201	KJ236	KJ219	KR219	DC27#14*2
757K-516H4-55GA/P	E214	D205	P509JP-A	LP226	KG255K-E	KJ204	KF203-E	KJ206-E	KD201	KJ236	KJ219	KR219	DC27#14*2
757K-516H4-55GA/P/EC	E214	D205	P509JP-A	LP226	KG255K-E	KJ204	KF203-E	KJ206-E	KD201	KJ236	KJ219	KR219	DC27#14*2
757K-516L1-24	E215	D206	P500J-A	LP225	KG252K-E	KJ204	KF203-E	KJ206-E	KD201	KJ236	KJ219	KR219	DC27#14*2
757K-516L1-24CT	E215	D206	P500J-A	LP225	KG252K-E	KJ204	KF203-E	KJ206-E	KD201	KJ236	KJ219	KR219	DC27#14*2
757K-516L1-35	E216	D206	P504J-A	LP225	KG253K-E	KJ204	KF203-E	KJ206-E	KD201	KJ236	KJ219	KR219	DC27#14*2

機 型 MODEL	針板 NEEDLE PLATE	送具 FEED DOG	送具 FEED DOG	送具 FEED DOG	押具 PRESSER FOOT	勾針 LOOPER	針留 NEEDLE CLAMP	束子 COLLER	衝程 CRANK	衝程 CRANK	大心 Crankshaft	勾針連桿座 Upper Looper	過線器 Bracket	下刀架 Lower Knife Holder	針號 NEEDLE
757K-516L1-35CT	E216	D206	D207	H212	P504J-A	LP225	KG253K-E	KJ204	KF203-E	KJ206-E	KD201	KJ236	KJ219	KR219	DC27#14*2
757K-516M2-35	E217	D208	D207	H208	P504J-A	LP226	KG253K-E	KJ204	KF203-E	KJ206-E	KD201	KJ236	KJ219	KR219	DC27#14*2
757K-516M2-35CT	E217	D208	D207	H208	P504J-A	LP226	KG253K-E	KJ204	KF203-E	KJ206-E	KD201	KJ236	KJ219	KR219	DC27#14*2
757K-516M2-35PS	E227	D208	D207	H214	P504JS-A	LP226	KG253K-E	KJ204	KF203-E	KJ206-E	KD201	KJ236	KJ219	KR219	DC27#14*2
757K-516M2-35PS/EC	E227	D208	D207	H214	P504JS-A	LP226	KG253K-E	KJ204	KF203-E	KJ206-E	KD201	KJ236	KJ219	KR219	DC27#14*2
757K-516M2-55	E218	D208	D207	H209	P502J-A	LP226	KG255K-E	KJ204	KF203-E	KJ206-E	KD201	KJ236	KJ219	KR219	DC27#14*2
757K-516M2-55CT	E218	D208	D207	H209	P502J-A	LP226	KG255K-E	KJ204	KF203-E	KJ206-E	KD201	KJ236	KJ219	KR219	DC27#14*2
757K-516M2-55EC	E218	D208	D207	H209	P502J-A	LP226	KG255K-E	KJ204	KF203-E	KJ206-E	KD201	KJ236	KJ219	KR219	DC27#14*2
757K-516M2-55PS	E228	D208	D207	H215	P502JS-A	LP226	KG255K-E	KJ204	KF203-E	KJ206-E	KD201	KJ236	KJ219	KR219	DC27#14*2
757K-516M2-55PS/EC	E228	D208	D207	H215	P502JS-A	LP226	KG255K-E	KJ204	KF203-E	KJ206-E	KD201	KJ236	KJ219	KR219	DC27#14*2
757K-401M2-50TA	E238	D211	D222	H216	P223-A	LP226	KG255K-E	KJ204	KF203-E	KJ206-E	KD201	TW201	KJ219	KR219	DC27#14*2
767K-516M2-324	E219	D208	D207	H209	P233J-A	LP226	KG433K-E	KJ234+KJL15	KF203-E	KJ203-E	KD201	KJ208	KJ219	KR219	DC27#11*3
767K-516M2-324/CT	E219	D208	D207	H209	P233J-A	LP226	KG433K-E	KJ234+KJL15	KF203-E	KJ203-E	KD201	KJ208	KJ219	KR219	DC27#11*3
767K-516M2-524	E224	D208	D207	H209	P255J-A	LP226	KG455K-E	KJ234+KJL15	KF203-E	KJ203-E	KD201	KJ208	KJ219	KR219	DC27#11*3
767K-516M2-524/CT	E224	D208	D207	H209	P255J-A	LP226	KG455K-E	KJ234+KJL15	KF203-E	KJ203-E	KD201	KJ208	KJ219	KR219	DC27#11*3

PARTS LIST FOR KA GROUP

PARTS LIST FOR KB GROUP

MODEL	700K/KD	986/988D
PARTS NO	KC230	KC231

MODEL	3線/4線	5線/6線
PARTS NO	KA224	

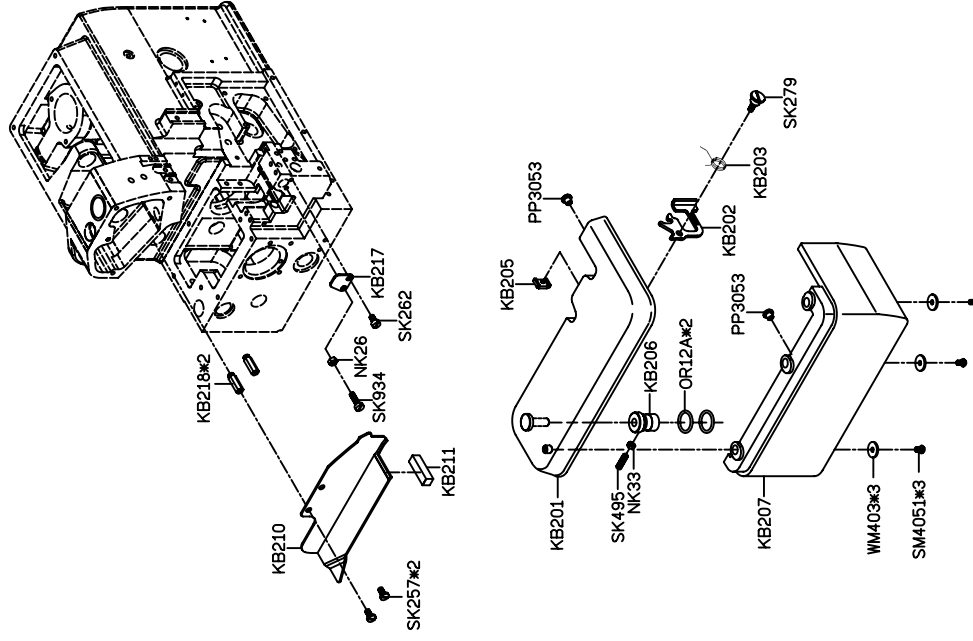
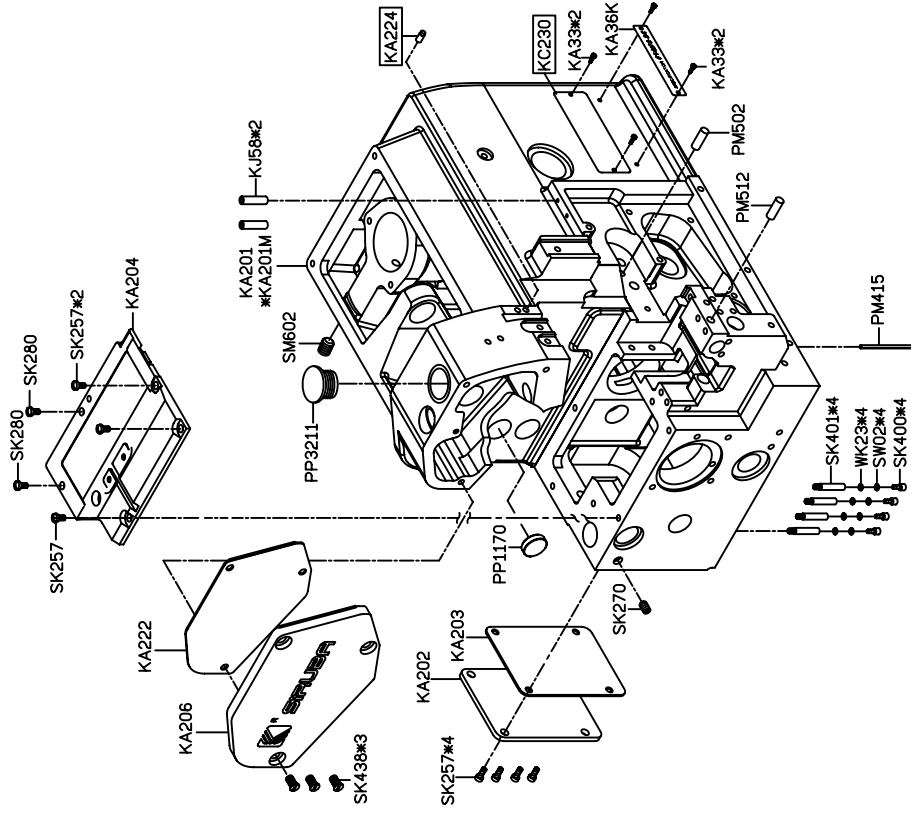

MODEL	3機/5機	4機/6機	4機M7/M8系列
PARTS NO	KJ204	KJ234+KJ15	KJ204+KJ23*2
	KJ206	KJ203	KJ203
	KJ236	KJ208	KJ228
	KJ219		KJ238

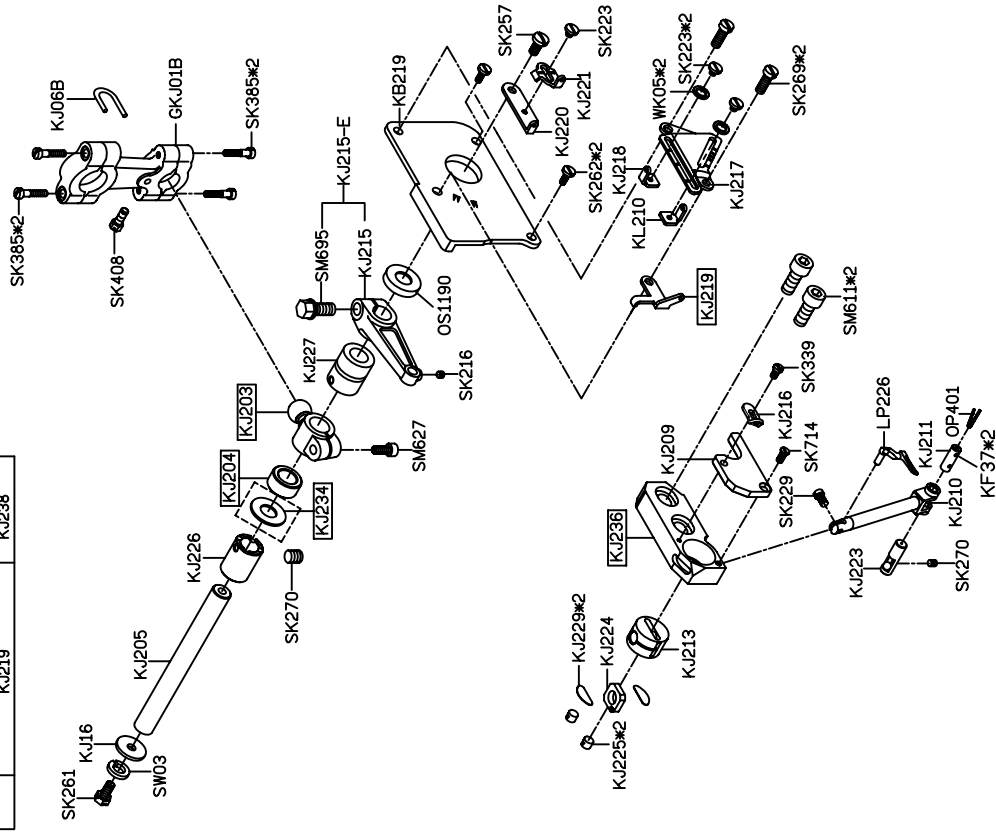

MODEL	3機/4機
PARTS NO	KL205

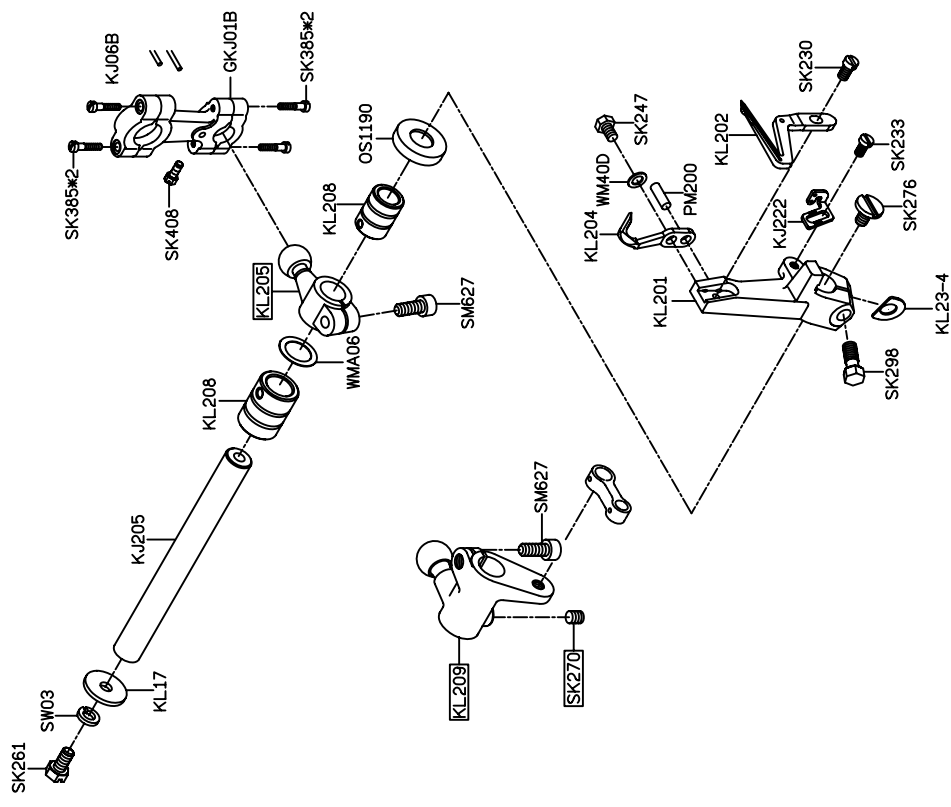

PARTS LIST FOR KM GROUP

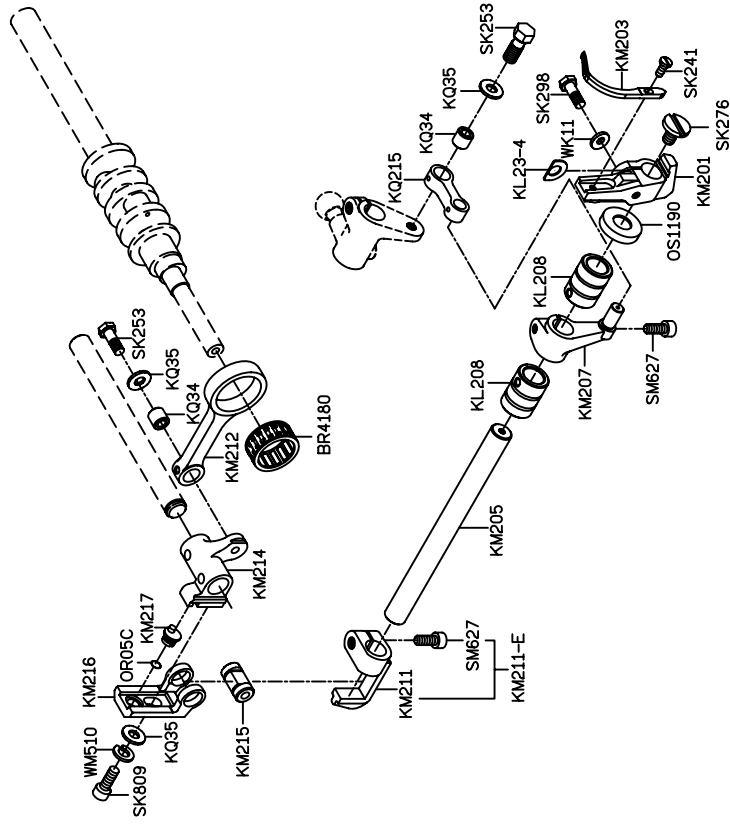

PARTS LIST FOR KN GROUP

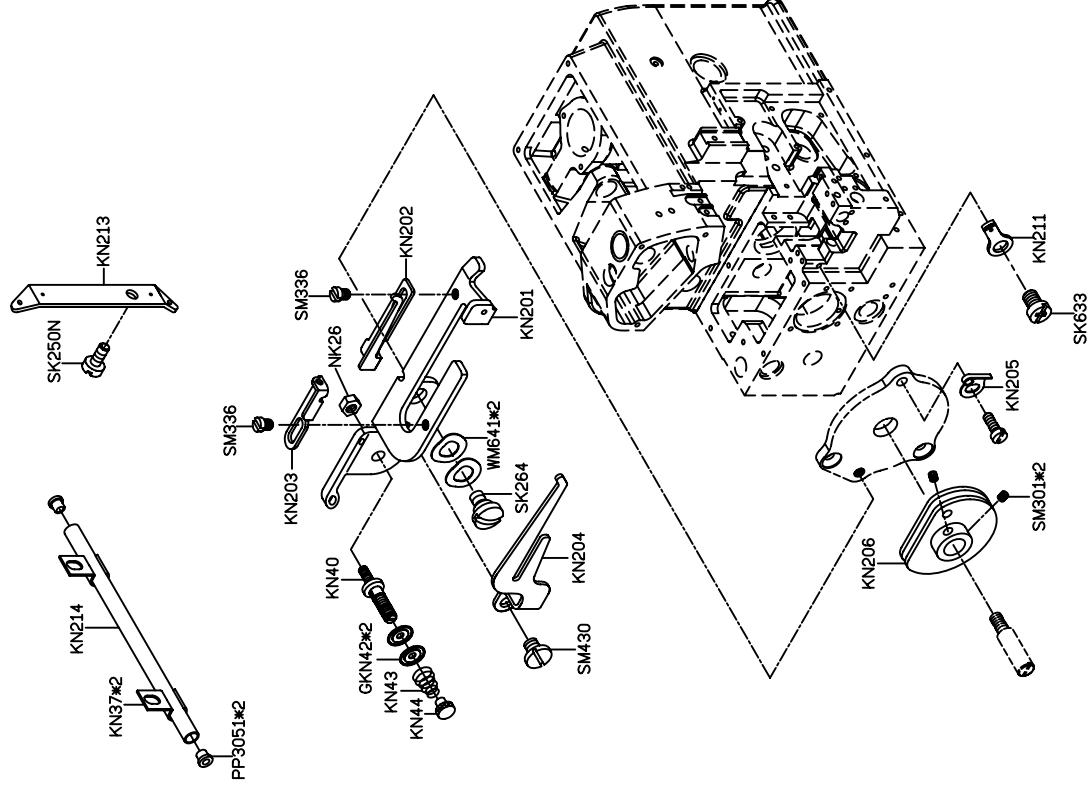

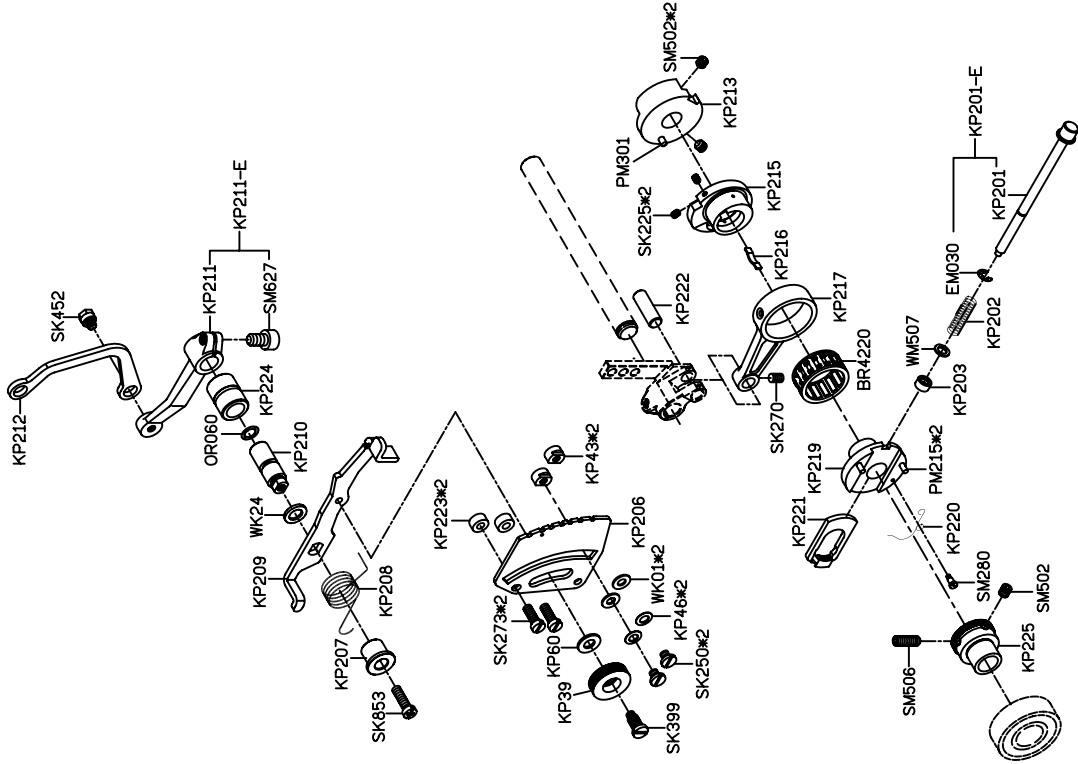

PARTS LIST FOR KP GROUP

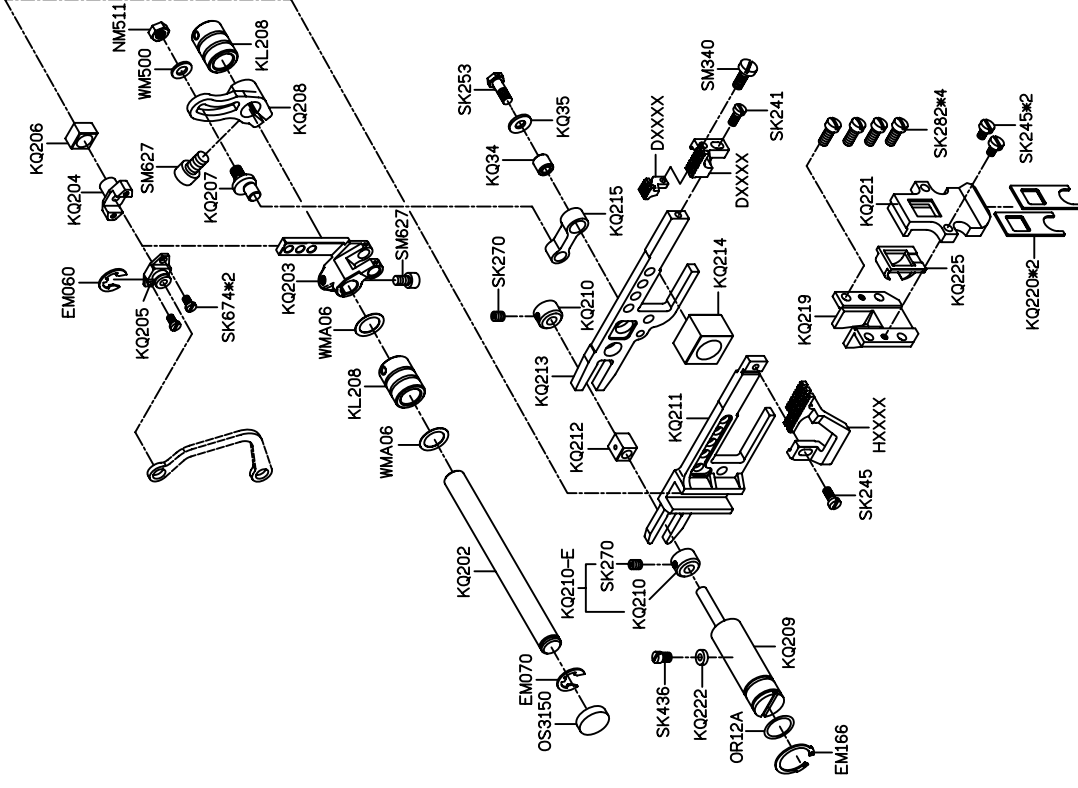

PARTS LIST FOR KQ GROUP

PARTS LIST FOR KR GROUP

MODEL	3線 / 4線	5線 / 6線
PARTS NO	KR202	KR218
	KR206	KR221
	KR209	KR219

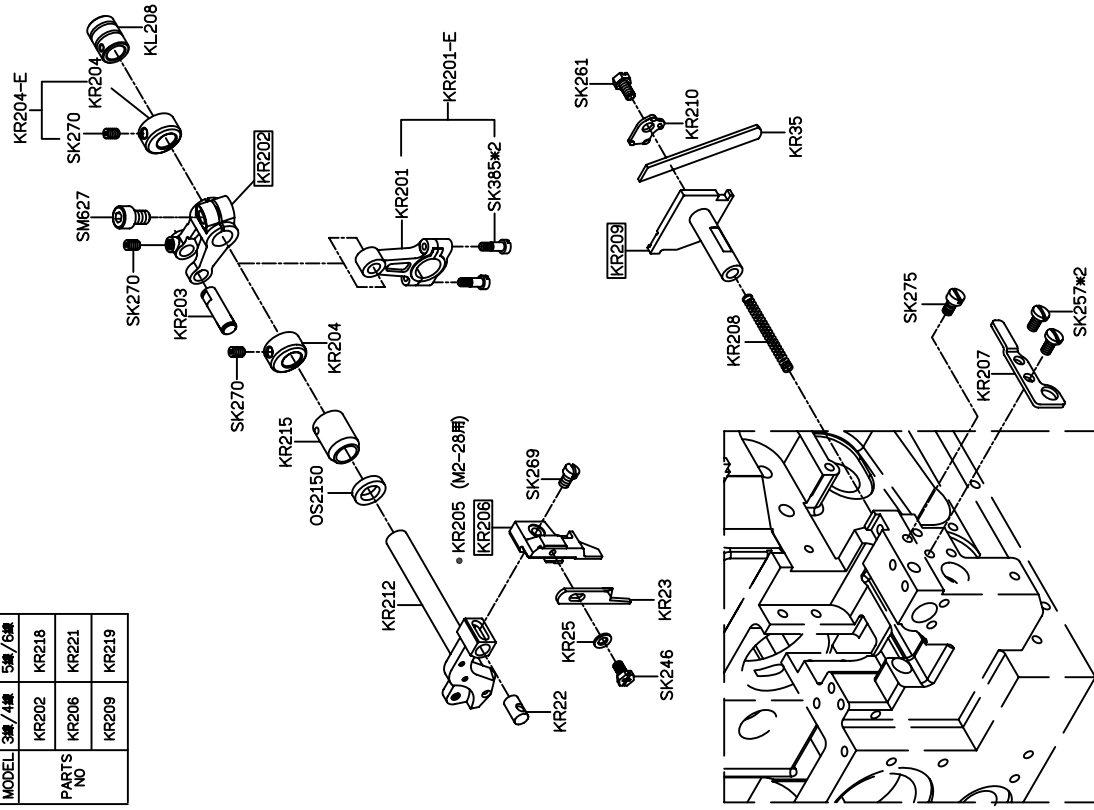

PARTS LIST FOR KS GROUP

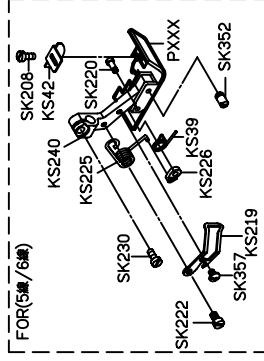
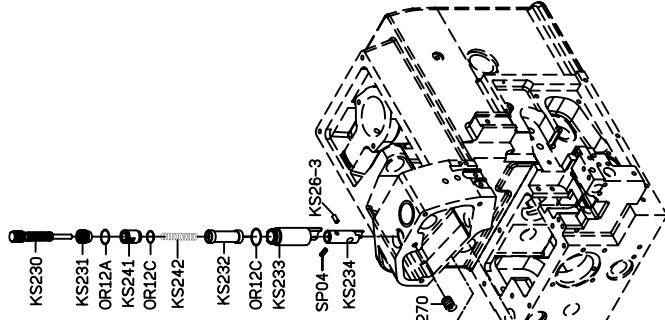
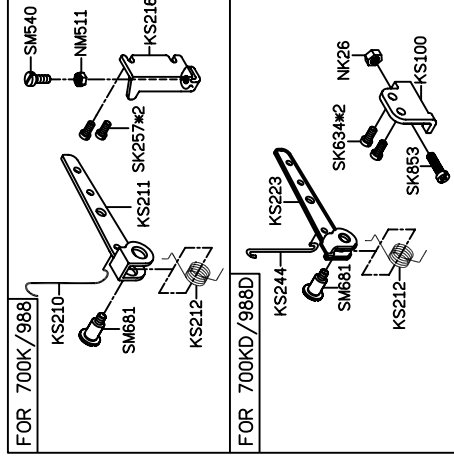

MODEL	3線/4線	5線/6線
PARTS NO	GKU40	GKU39
	KU207	KU209
	KU206	KU211
	SK277	SK437

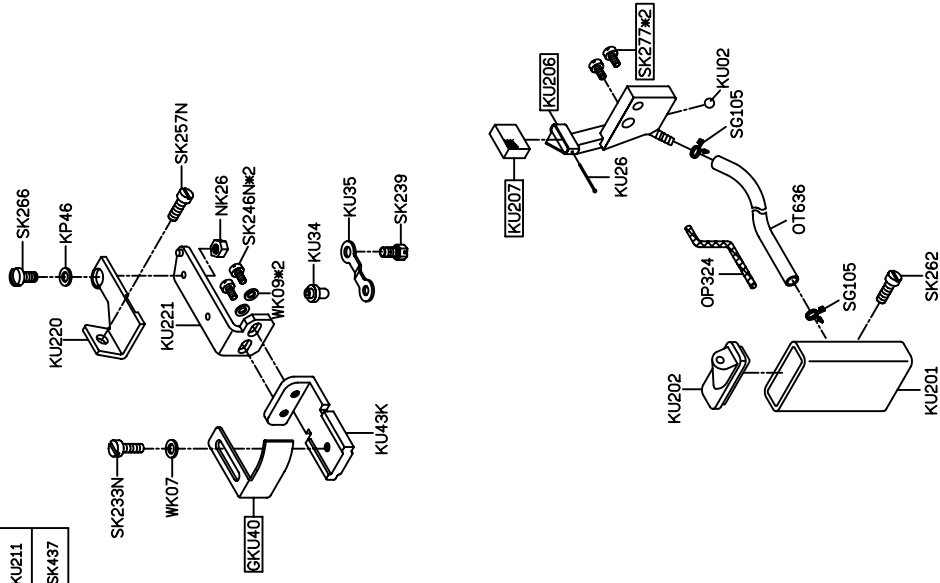
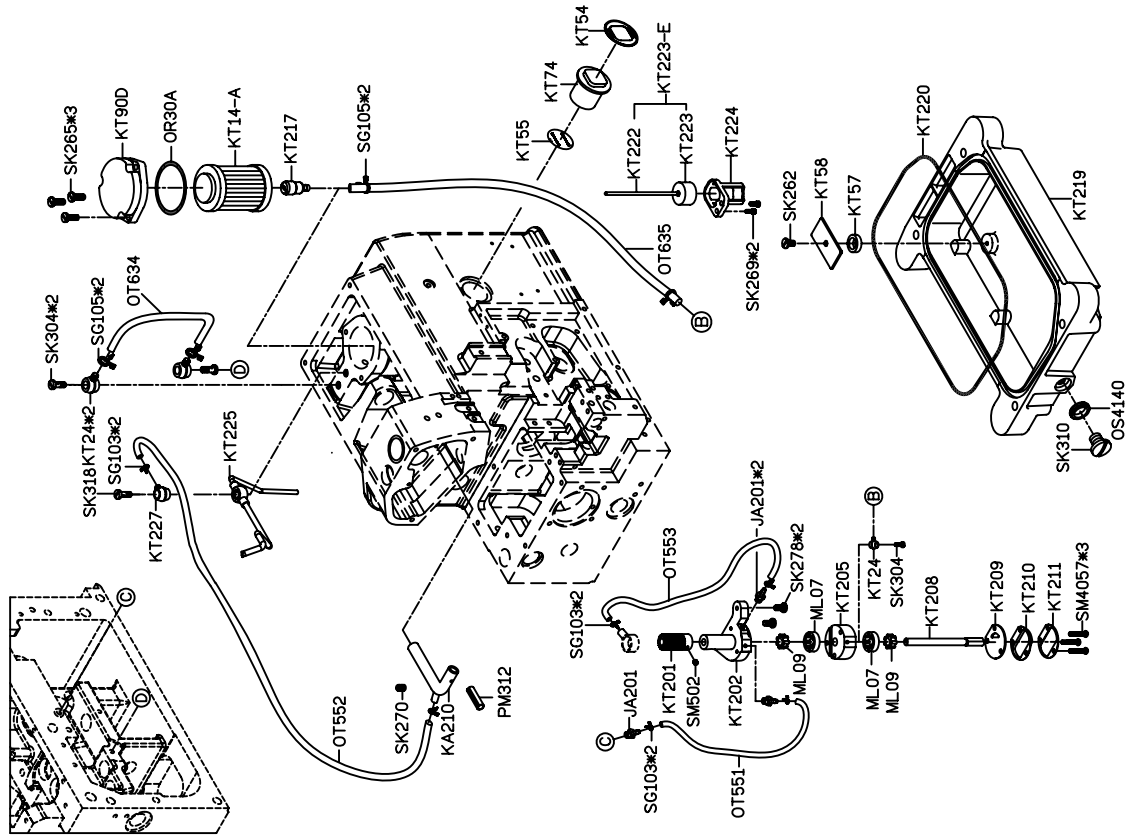

PARTS LIST FOR KW GROUP

PARTS LIST FOR KW GROUP

KW40E-3

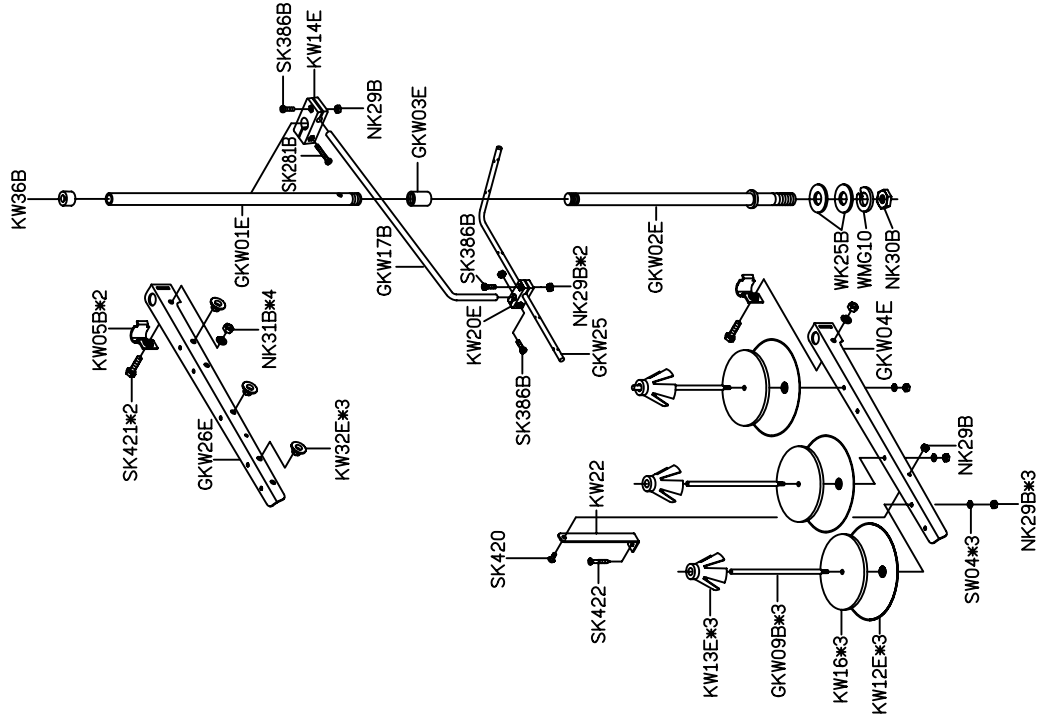

KW40E-4

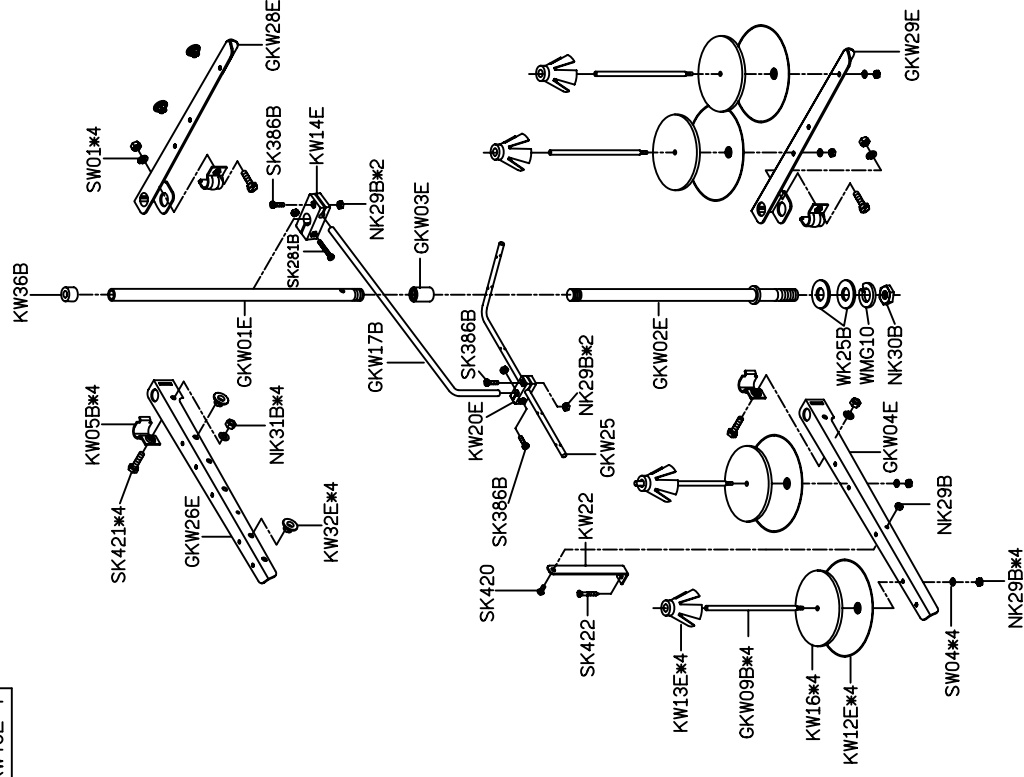



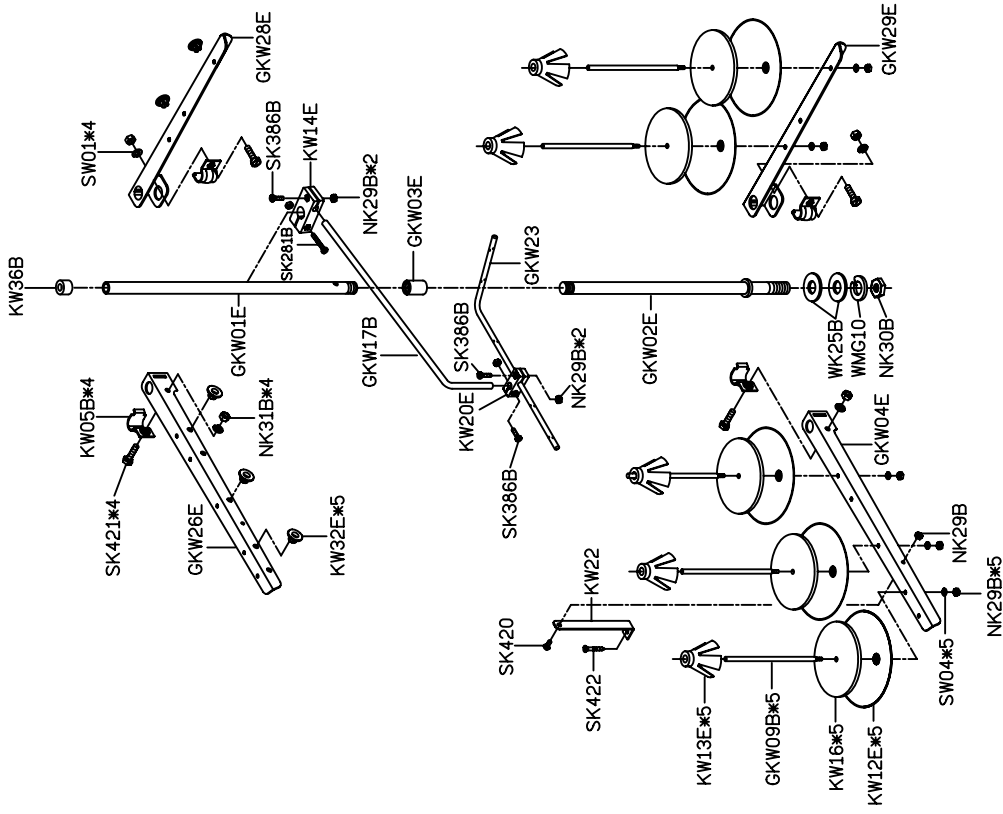



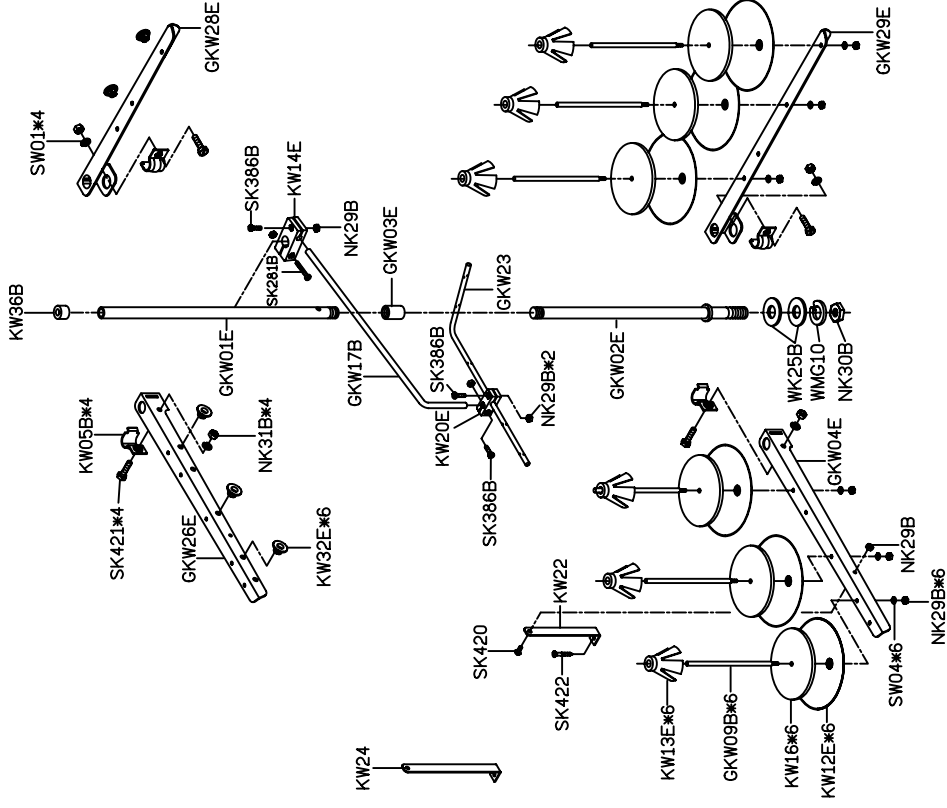

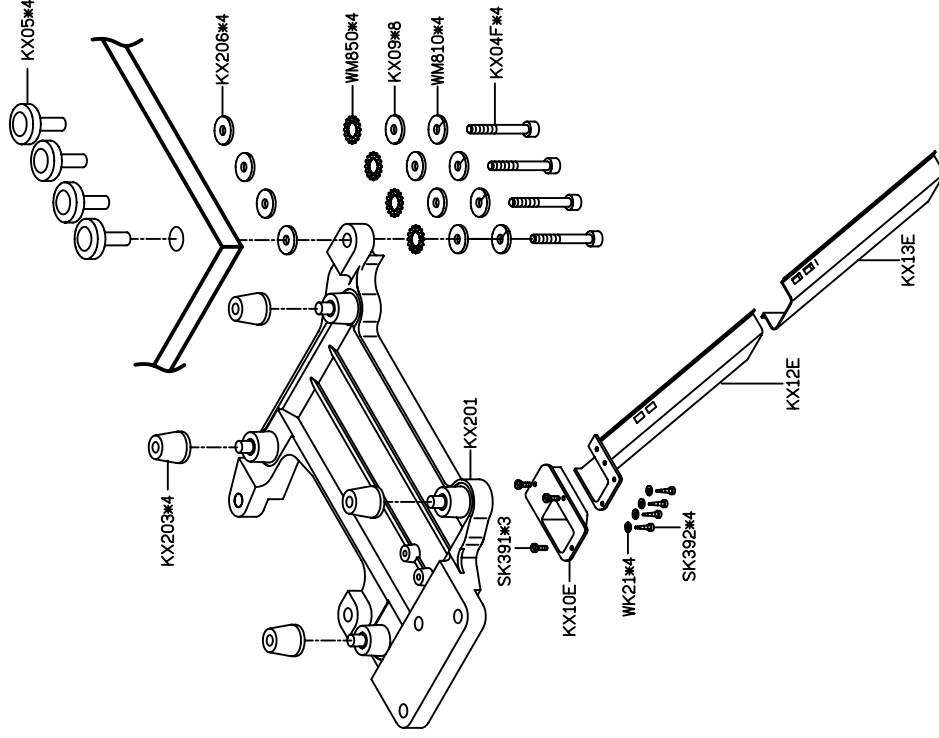





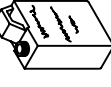

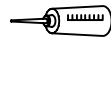







KW40E-5



KW40E-6





GKY01-1 防塵罩 	KY07 開口板手 	KY12 六角板手 	KY02F-A 油罐 	KY08 開口板手 	KY14 內六角螺絲起子 	KY03 油壺 	KY09 開口板手 	KY16 一字起子 	KY21-A/MY21 鉤子/鍊條 	GKY200 腳踏板 	KY19 穿線器 	KY04 漏斗 	KY10 六角板手 	KY17 一字起子 	KY21-A/MY21 鉤子/鍊條 	KZ03 乾燥濟 	KZ08J 使用說明書 	KY05-A 油壺 	KY11 六角板手 	KY18 鑷子 	GKY26F 工具袋 	針*5 車針 	KZ08J-2 零件圖 	*KC276-A 燈座電器組 
--	--	--	--	---	--	---	---	---	---	--	---	---	---	---	---	--	---	---	---	---	--	--	---	--

MODEL	700K/KD	988/988D
PARTS NO	KZ53K	KZ53K-1
	*KZ53KD	*KZ53KD-1

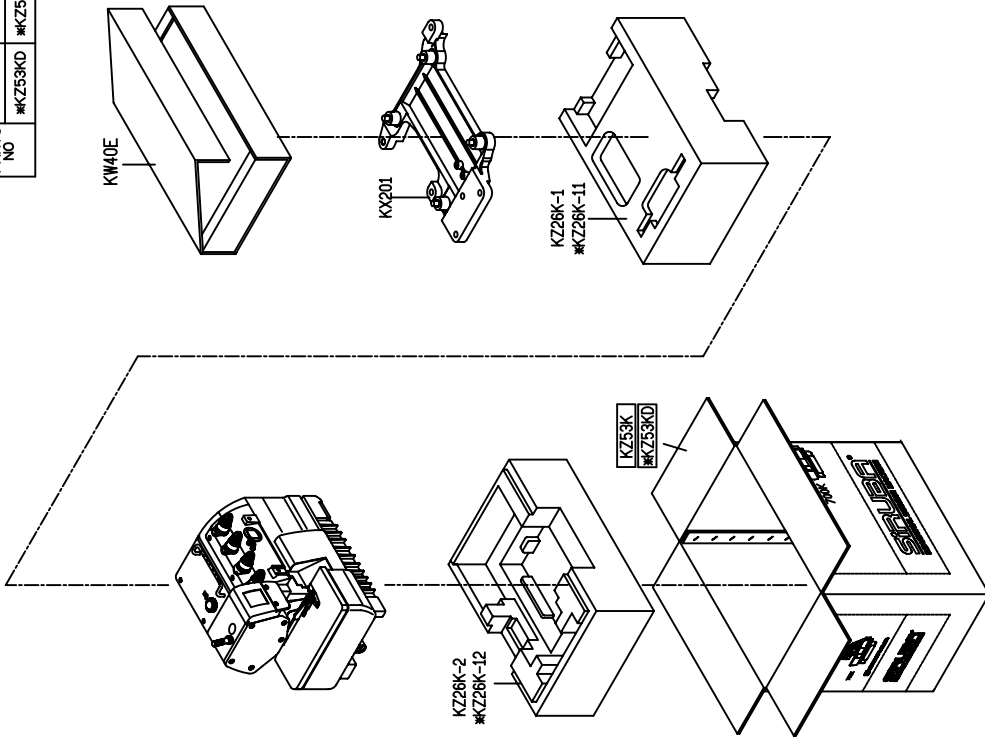



700K

高林股份有限公司 KAULIN MFG. CO., LTD.